

TIR VE BİSİKLET PROFİLLERİ

TRUCK & BICYCLE PROFILES

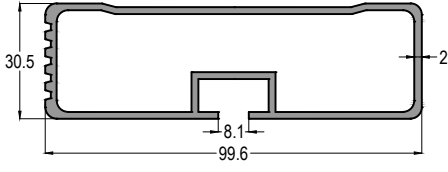

16-099030-18

1,445 Kg/mt

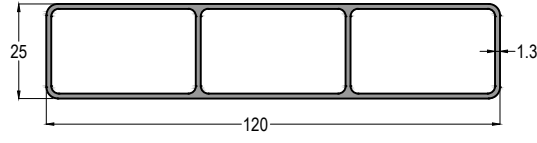

16-120025-13

1,165 Kg/mt

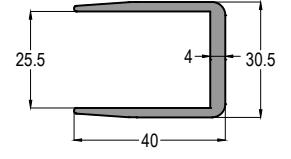

16-040030-25

0,760 Kg/mt

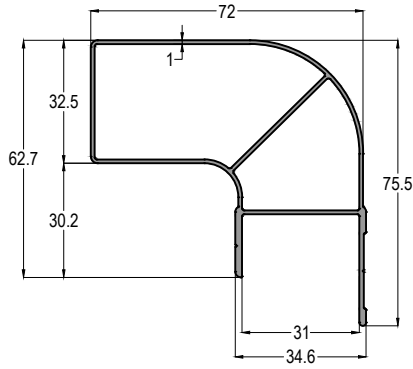

13-09408

0,872 Kg/mt

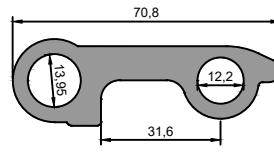

16-071230-90

2,047 Kg/mt

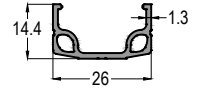

13-026014-15

0,245 Kg/mt

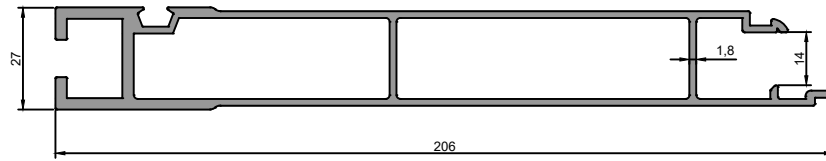

16-205025-18

2,741 Kg/mt

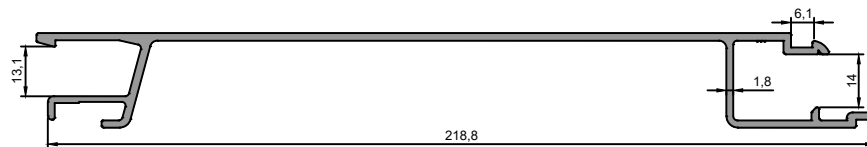

16-217025-18

2,468 Kg/mt

TIR VE BİSİKLET PROFİLLERİ

TRUCK & BICYCLE PROFILES

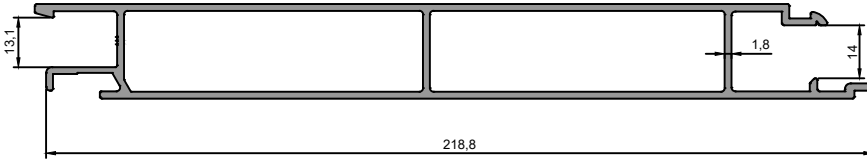

16-218025-18

2,538 Kg/mt

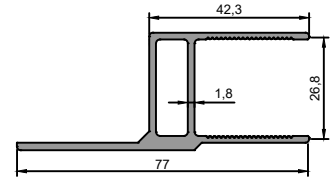

16-077031-18

0,905 Kg/mt

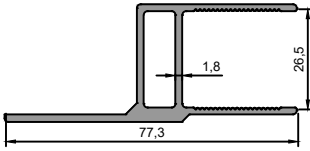

16-082030-26

1,458 Kg/mt

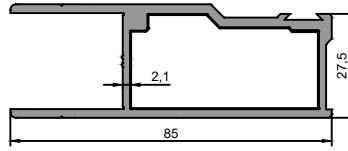

16-085030-23

1,485 Kg/mt

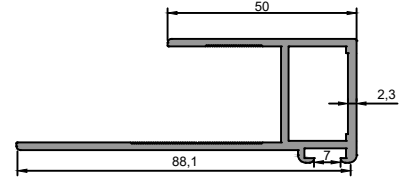

16-090029-20

1,092 Kg/mt

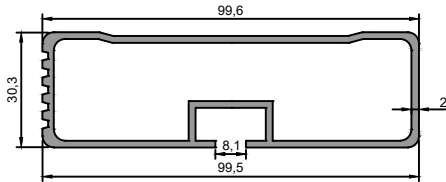

16-099030-18

1,450 Kg/mt

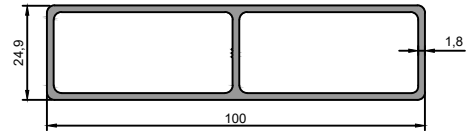

16-100025-18

1,298 Kg/mt

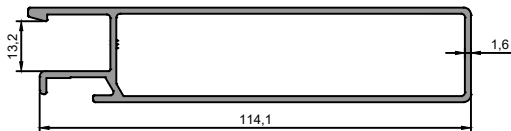

16-117025-16

1,274 Kg/mt



16-120025-13

1,168 Kg/mt

TIR VE BİSİKLET PROFİLLERİ

TRUCK & BICYCLE PROFILES

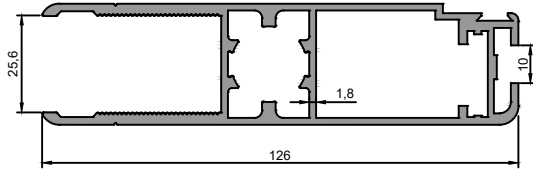

16-126320-18

2,236 Kg/mt

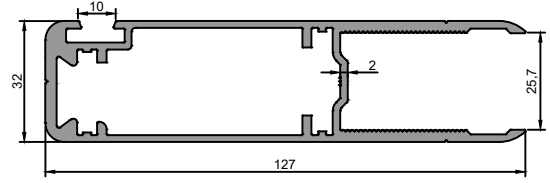

16-127320-18

2,171 Kg/mt

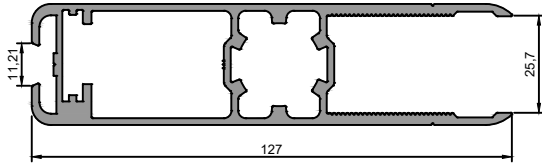

16-127322-18

2,344 Kg/mt

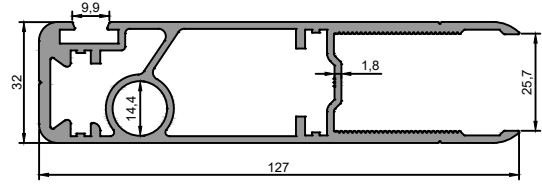

16-127323-18

2,463 Kg/mt

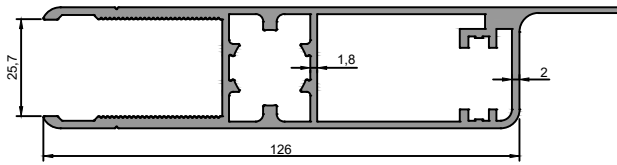

16-153320-18

2,393 Kg/mt

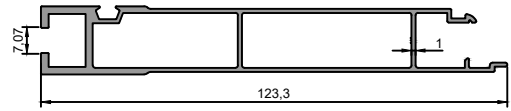

16-185025-16

1,038 Kg/mt

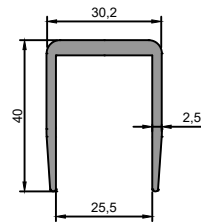

16-040030-25

0,762 Kg/mt

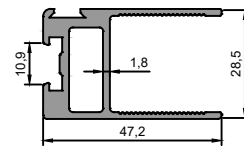

16-047029-18

0,889 Kg/mt